

# Clamp On Line Tensionmeter



**The Straightpoint COLT is a lightweight tensionmeter for fast and accurate measurement of wire rope tensions up to 11,000lbf/5000 kgf and up to 1"/25mm diameter.**

Manufactured using an integral, high accuracy, Bluetooth module the COLT transmits load data wirelessly to any smart device running our Android or iOS app.

As the library of wire rope diameters and constructions is increased each app user will benefit when they update and receive any new data.

A useful data-logging feature within the app allows the operator to log changes in tension v time and date if required; this data can then be emailed or uploaded to the cloud straight from the smart device in use.

Constructed from aerospace grade aluminium the COLT digital tensionmeter is lightweight and easy to handle and operates on wires that are already under tension.

Once in place it allows the operator to quickly check tension on cables or wire ropes set at any angle.

A built in smart device holder allows the COLT to be used as a traditional tension meter with on board display or the smartphone maybe handheld or mounted elsewhere.

Supplied in a purpose made carry case the COLT is portable and utilises standard alkaline batteries making this perfect for on-site cable tension measurement across the world.

## Features and benefits:

- Unlimited wire rope calibration database via Android or iOS app
- Main swivel joints fitted with high quality bearings
- Lever ratio of 5.3:1 allows effortless, safe, clamping onto pre-tensioned wire ropes
- Wireless Bluetooth enabling operator to stand at safe distance if needed
- Quick intuitive adjustable centre sheave makes changing wire rope sizes fast and easy
- No easily broken external antennae
- High waterproof resistant design for all weather use
- Massive battery life of 1000 hours operational time



**making the lifting industry a safer place**

## Applications:

- Guy wire maintenance on cell towers, bridges, stacks, antennas and masts
- Wire rope installations, comparing, equalising and measuring
- Median cable barrier tensioning
- Utility cable overhead line monitoring
- Elevator hoist, governor and compensating wire rope maintenance
- Zip lines and assault course testing
- Fall arrest systems
- Metro, tram and rail transit electric wires and catenary testing
- Ski lifts

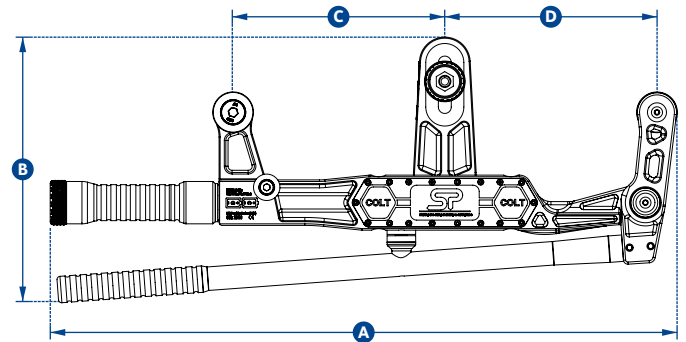

Part Number	COLT5T
Max Load	5000kg
	11000lbs
Resolution	10kg
	20lb
Units	kg, lbs, tonne and kN
Min Wire Rope Ø	Ø5mm
	Ø3/16"
Max Wire Rope Ø	Ø25mm
	Ø1"
Max Line Reduction	5mm with a Ø10mm wire rope
	7/32" with a Ø3/8" wire rope
Wire Rope Database	Infinite via Android 4.4 or iOS 8.0 app
Weight	3.5kg
	7.7lbs
Battery Type	2 x 'C' cell batteries
Battery Life	1000 hours Bluetooth transmission time
Operating Temp.	-25°C to +70°C
	-13°F to +158°F
Protection	IP67
	NEMA 6
Accuracy	± 3% of full scale if wire rope Ø and construction known
Communication	Bluetooth 4.1
Dimension A	589mm
	23.2"
Dimension B	254mm
	10"
Dimension C	200mm
	7.9"
Dimension D	200mm
	7.9"